

-  **Antenne**
-  Antennas
-  Antenne
-  Antenas

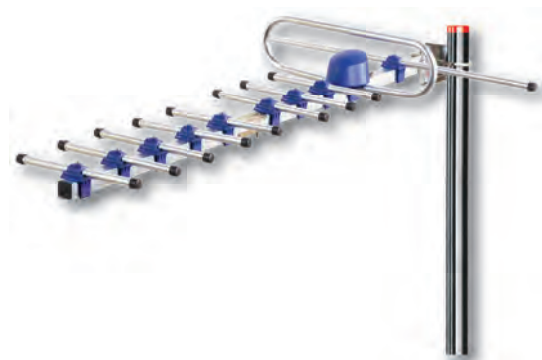

## Antenne TV

Antenne Logarithmiche,  
Antenna Tripla,  
Antenna Yaghi  
per impianti centralizzati e distribuzione del  
segnale TV.

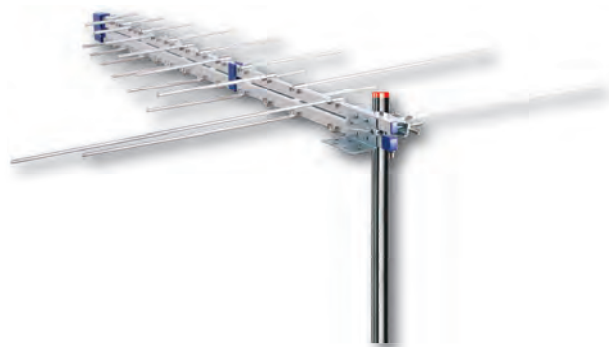

## TV Antennas

Logarithmic Antennas,  
Triple Antenna,  
Yaghi Antenna  
for centralized systems and distribution of TV signal.



## Antenne TV

Antenne logarithmique,  
Triple antenne,  
Yaghi antenne  
pour les systèmes centralisés et de la distribution du  
signal TV.





## Antennas TV

Logarítmica Antena,  
Antena triple,  
Yaghi Antena  
para sistemas centralizados y distribución de señal de TV.



 **Antenne logaritmiche**

 Logarithmic antennas

 Antenne logarithmique

 Antena logarítmica



 Antenna log. e log. UHF

 Logarithmic & logarithmic UHF antenna

 Antenne logarithmique et log. UHF

 Antena logarítmica y logaritmica UHF



MODELLO  
CODICE

**3BLOGF**  
**9653**

**3BULOG16**  
**9656**

**3BULOG28**  
**9657**

<b>ELEMENTI</b> ELEMENTS	28	16	28
<b>CANALI</b> CHANNELS	E5÷60	E21÷60	E21÷60
<b>LARG. BANDA</b> FREQUENCY	175÷790 MHz	470÷790 MHz	470÷790 MHz
<b>GUADAGNO</b> GAIN	12 dB	10.5 dB	11.5 dB
<b>POLARIZZAZIONE</b> BEAM WIDTH	H 32°/ V 35°	H 60°	H 60°
<b>IMPEDENZA</b> IMPEDANCE	75 Ω	75 Ω	75 Ω
<b>RAPP. AVANTI/INDIET.</b> FRONT/BACK RATIO	>25 dB	>25 dB	>25 dB
<b>LUNGHEZZA</b> LENGTH	970mm	620mm	935mm

## ANTENNA TRIPLA E VHF

## Antenne TV

**3B elettronica**  
Applicazioni elettroniche

### **Antenna tripla e vhf**

 VHF & Triple antenna

 Antenne triple e vhf

 Antena triples y vhf



 Antenna tripla UHF 42 elementi  
guadagno 12÷32dB e  
VHF 7 elementi

 Triple antenna UHF 42 elements  
gain 12÷32dB  
and VHF 7 elements

 Antenne triple UHF 42 éléments  
gain de 12÷32dB  
e VHF 7 éléments

 Antena triples 42 elementos  
ganancia 12÷32dB  
y VHF 7 elementos

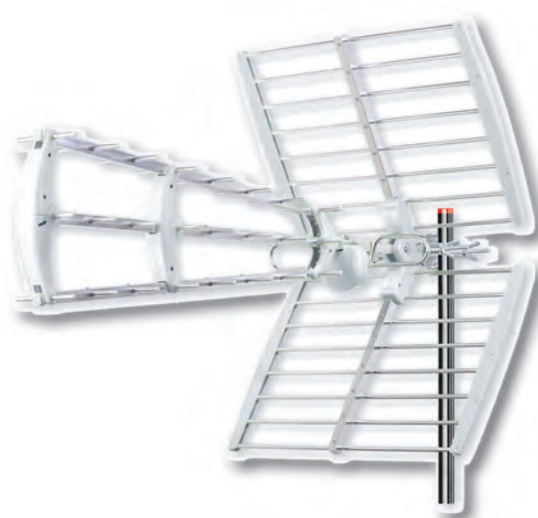

MODELLO  
CODICE

**3B343FB**  
**9652**

<b>ELEMENTI</b>	
ELEMENTS	42
<b>CANALI</b>	
CHANNELS	21 ÷ 60
<b>LARG. BANDA</b>	
FREQUENCY	470 ÷ 790 MHz
<b>GUADAGNO</b>	
GAIN	12 ÷ 17 dB
<b>POLARIZZAZIONE</b>	
BEAM WIDTH	H 32°/ V 35°
<b>IMPEDENZA</b>	
IMPEDANCE	75 Ω
<b>RAPP. AVANTI/INDIET.</b>	
FRONT/BACK RATIO	>27 dB
<b>LUNGHEZZA</b>	
LENGTH	1050mm

## ANTENNA YAGHI

## Antenne TV

**3B elettronica**  
Applicazioni elettroniche

 **Antenna yaghi**

 Yaghi antenna

 Antenne yaghi

 Antena yaghi



 Antenna yaghi UHF 10 elementi  
guadagno 8dB

 Yaghi antenna UHF 10 elements  
gain 8dB

 Antenne yaghi UHF 10 éléments  
gain de 8dB

 Antena yaghi UHF 10 elementos  
ganancia 8dB



MODELLO  
CODICE

**3B143**  
**9651**

<b>ELEMENTI</b>	10
ELEMENTS	
<b>CANALI</b>	21 ÷ 60
CHANNELS	
<b>LARG. BANDA</b>	470 ÷ 790 MHz
FREQUENCY	
<b>GUADAGNO</b>	5 ÷ 8 dB
GAIN	
<b>POLARIZZAZIONE</b>	H 32° / V 35°
BEAM WIDTH	
<b>IMPEDENZA</b>	75 Ω
IMPEDANCE	
<b>RAPP. AVANTI/INDIET.</b>	> 18 dB
FRONT/BACK RATIO	
<b>LUNGHEZZA</b>	675mm
LENGTH	

  
Lte™



**INSERIMENTO ELEMENTI**  
**A SCATTO**